

AssureFlex® Tri-Flex Loop® Expansion Loops & Seismic Connectors for Fire Protection

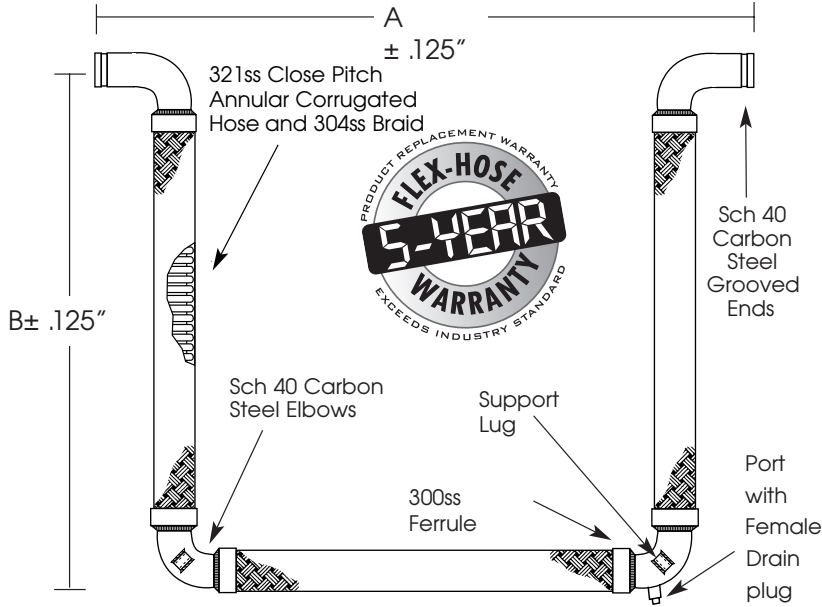

CSA standard B-51 certified.
Inspected and tested by the
Technical Standards and
Safety Authority of Canada.

Qty	I.D. (in.)	Dimensions		Pressure (PSI) @70° F	Movement Capability					Drain Port (in.)	Wt. (lb.)	Notes
		"A" (in.)	"B" (in.)		Compression (in.)	Extension (in.)	Parallel (in.)	Rotate "X" Axis (Deg.)	Non- parallel "Y" Axis (in.)			
	2.00	37.00	28.25	300	4.0	4.0	4.0	20°	2.0	½"	18	
	2.50	41.00	31.00	300	4.0	4.0	4.0	20°	2.0	¾"	30	
	3.00	45.25	34.00	300	4.0	4.0	4.0	15°	2.0	¾"	40	
	4.00	55.75	40.00	175	4.0	4.0	4.0	10°	2.0	¾"	70	
	5.00	71.25	51.00	175	4.0	4.0	4.0	10°	2.0	¾"	126	
	6.00	77.00	54.25	175	4.0	4.0	4.0	5°	2.0	¾"	189	
	8.00	92.00	63.25	175	4.0	4.0	4.0	5°	2.0	¾"	362	
	10.00	110.00	74.38	175	4.0	4.0	4.0	5°	2.0	¾"	587	
	12.00	125.00	84.38	175	4.0	4.0	4.0	3°	2.0	¾"	861	

Working pressures shown for the hose and braid are based on an operating temperature of 70°F (21°C) with a 4:1 safety factor.
8" - 12" provided double braid

Movement Capability

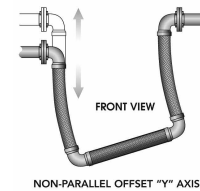
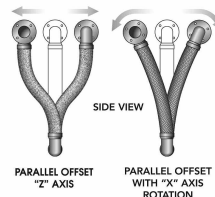
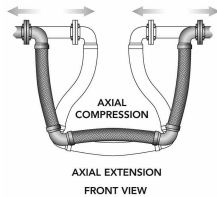

PROJECT	
CUSTOMER	
ENGINEER	
REPRESENTATIVE	
DRAWING #	



4560 Buckley Road • Liverpool, NY USA 13088-2509
315/437-1611 • Fax 315/437-1903
www.flexhose.com • 1.877.TRI FLEX